



Please read this document carefully before using this product. The guarantee will be invalidated if the device is damaged by not following instructions detailed in the manual. The company shall not be responsible for any damage or losses however caused, which may be experienced as a result of the installation or use of this product.

ENDA ETM1411 DIGITAL TIMER

Thank you for choosing ENDA ETM1411 digital timer.

- * 35 x 77mm sized.
- * Single contact output for timing control.
- * External start input.
- * Display can be adjusted to show min. or sec.
- * Scale ;
0:01 99:59 mins.
0:01 99:59 hrs.
- * Decrease and increase step of time can be adjusted.
- * Start and stop possibility by front panel.
- * 16 different warning tones.
- * Upper and lower limits of the setpoint can be adjusted.
- * CE marked according to European Norms.

CE **RoHS Compliant**

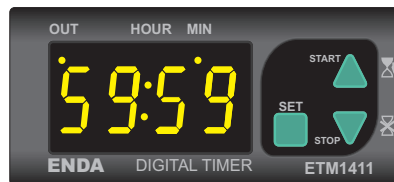

Order Code : ETM1411-□□□□□□

1

1-Supply Voltage

- 230VAC...230V AC
- 24.....24V AC/DC
- 12.....12V AC/DC

Connection Diagram



ENDA ETM1411 is intended for installation in control panels. Make sure that the device is used only for intended purpose. The shielding must be grounded on the instrument side. During an installation, all of the cables that are connected to the device must be free of electrical power. The device must be protected against inadmissible humidity, vibrations, severe soiling. Make sure that the operation temperature is not exceeded. All input and output lines that are not connected to the supply network must be laid out as shielded and twisted cables. These cables should not be close to the power cables or components. The installation and electrical connections must be carried out by a qualified staff and must be according to the relevant locally applicable regulations.

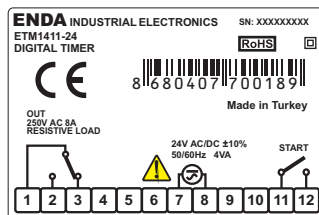
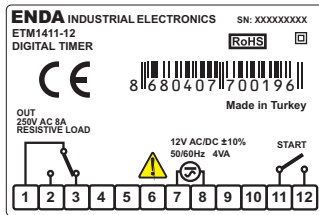
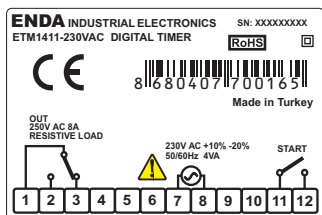

Equipment is protected throughout by DOUBLE INSULATION.

Holding screw 0.4-0.5Nm

NOTE :

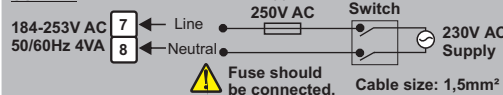

NOTE:

- 1) Mains supply cords shall meet the requirements of IEC 60227 or IEC 60245.
- 2) In accordance with the safety regulations, the power supply switch shall bring the identification of the relevant instrument and it should be easily accessible by the operator.

TECHNICAL SPECIFICATIONS

ENVIRONMENTAL CONDITIONS	
Ambient/storage temperature	0 ... +50°C/-25 ... +70°C (with no icing)
Max. Relative humidity	80% up to 31°C decreasing linearly 50% at 40°C.
Rated pollution degree	According to EN 60529 Front panel : IP65 Rear panel : IP20
Height	Max. 2000m

⚠ Do not use the device in locations subject to corrosive and flammable gases.

ELECTRICAL CHARACTERISTICS	
Supply	230V AC +10% -20%, 50/60Hz or 24V AC/DC ±10%, 50/60Hz or 12V AC/DC ±10%, 50/60Hz
Power consumption	Max 4VA
Wiring	2.5mm² screw-terminal connections
Scale	Selectable 99:59 min. or hour.
Sensitivity	1 sec.
Time Accuracy	±1%
Indicator	4 digits, 12.5mm, 7 segment yellow LED
EMC	EN 61326-1: 2006
Safety requirements	EN 61010-1: 2010 (pollution degree 2, overvoltage category II)

OUTPUT	
OUT	Relay: 250V AC, 8A (for resistive load), NO+NC
Life expectancy for relay	Mechanical 30.000.000 operation; Electrical 100.000 operation

START INPUT	
Input type	Control with mechanical contact.
On and Off times for input pulses	Min. = 100ms

HOUSING	
Housing type	Suitable for flush-panel mounting
Dimensions	W77xH35xD71mm
Weight	Approx. 198g (after packing)
Enclosure material	Self extinguishing plastics

⚠ While cleaning the device, solvents (thinner, benzine, acid etc.) or corrosive materials must not be used.

Dimensions

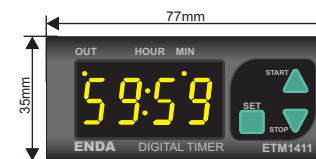

To remove the device from panel:
- While pushing the the flush-mounting clamp in direction 1, pull out it in direction 2.

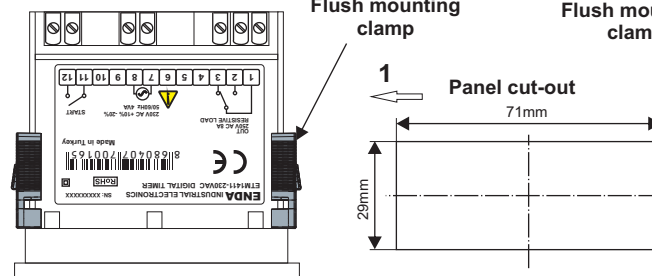
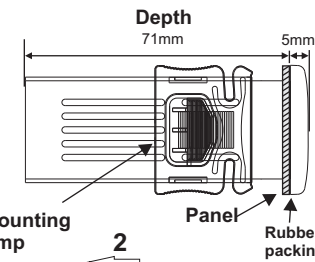

Note: 1) Panel thickness should be maximum 7 mm.
2) If there is no 60mm free space at the back side of the device, it would be difficult to remove it from the panel.

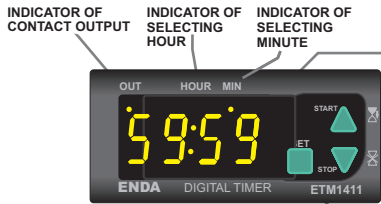

Displayed time value in the run mode, parameter value or name in the programming mode.

When held down for one second in the run mode, timer runs. Used for selecting menu and increasing setpoint value of the parameters in the programming mode and for increasing the setpoint value in the run mode. When held down for a few seconds, the change rate accelerates.

When held down for one second in the run mode, timer and voiced warning are stopped. (When $Str.t = tYP.1$ mode is selected, timer and voiced warning can be stopped if external start input is off). Used for selecting parameters and decreasing the setpoint value in the programming mode and for decreasing the setpoint value in the run mode. When held down for a few seconds, the change rate accelerates.

Used for adjusting the value of the setpoint in the run mode and for adjusting the selected parameter in the programming mode. For adjusting the selected parameter, while holding \blacksquare key, the value can be adjusted by using \blacktriangle and \blacktriangledown keys.

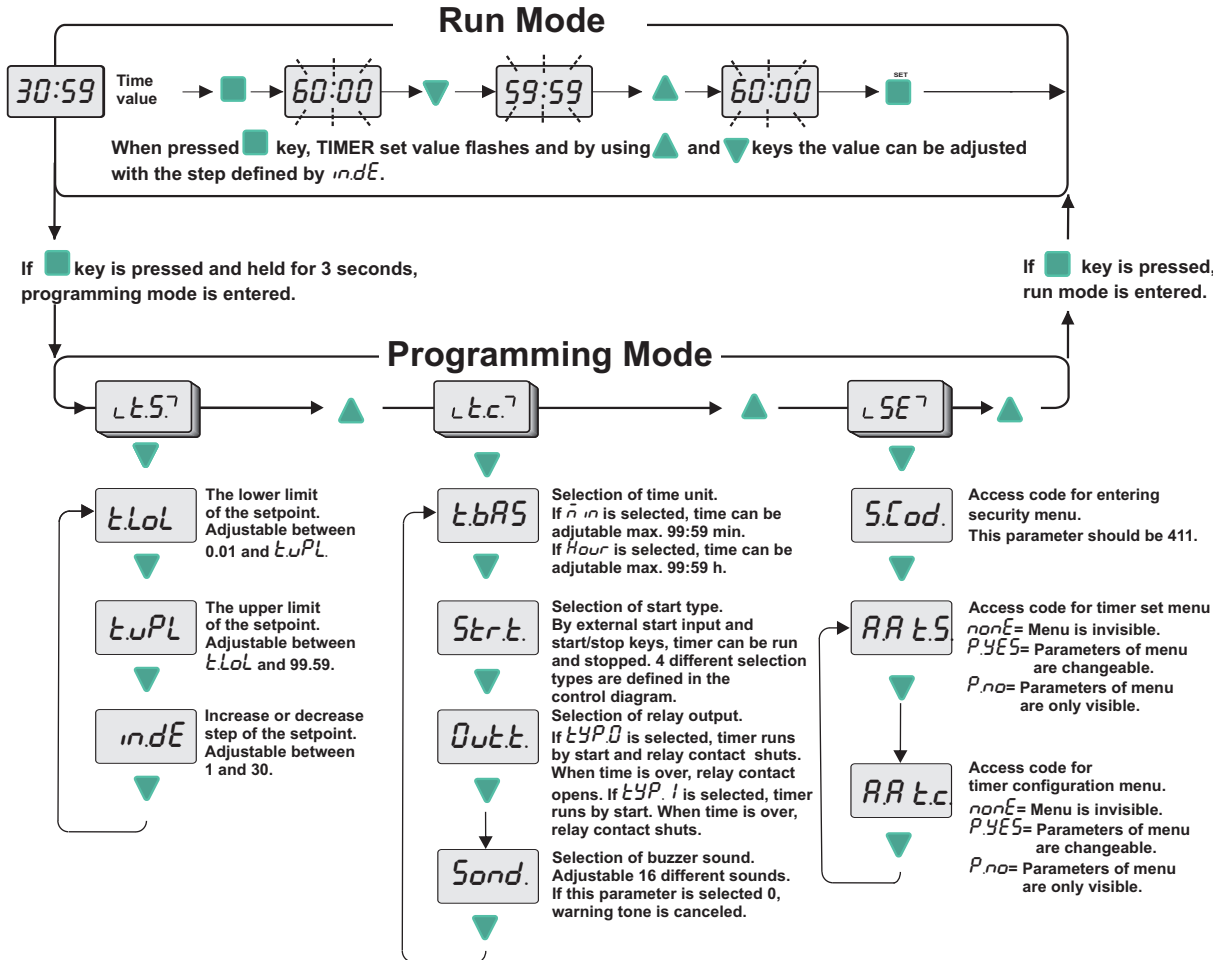

CONTROL DIAGRAM BY EXTERNAL START INPUT

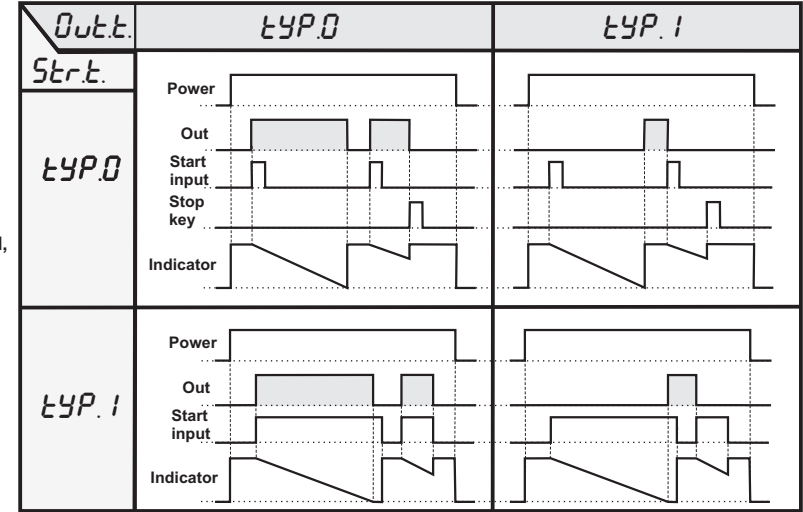

CONTROL DIAGRAM BY START & STOP KEYS

