

# General purpose relays 6 - 10 A



Shipyards



Hoists and cranes



Road / tunnel  
lighting



Burners,  
boilers and  
furnaces



Wood-processing  
machines



Panels for electrical  
distribution



Control panels



Control systems

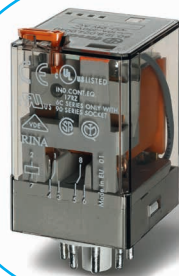



**Plug-in mount**  
**10 A General purpose relay**

**Type 60.12**

- 2 pole, 10 A

**Type 60.13**

- 3 pole, 10 A

- 2 & 3 pole changeover contacts
- Cadmium Free contacts (preferred version)
- AC coils & DC coils
- UL Listing (certain relay/socket combinations)
- Contact material options
- Lockable test button with mechanical flag indicator (preferred version)
- 90 series sockets
- Coil EMC suppression
- Timer accessories 86 series
- European Patent

FOR UL RATINGS SEE:

"General technical information" page V

For outline drawing see page 8

**60.12**



- 2 pole, 10 A
- 8 pin plug-in

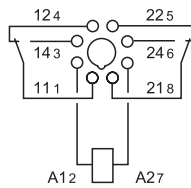

**60.13**



- 3 pole, 10 A
- 11 pin plug-in

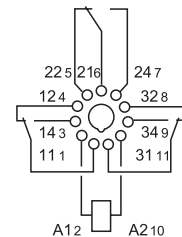

**Contact specification**

Contact configuration		2 CO (DPDT)	3 CO (3PDT)
Rated current/Maximum peak current	A	10/20	10/20
Rated voltage/ Maximum switching voltage	V AC	250/400	250/400
Rated load AC1	VA	2500	2500
Rated load AC15 (230 V AC)	VA	500	500
Single phase motor rating (230 V AC)	kW	0.37	0.37
Breaking capacity DC1: 24/110/220 V	A	10/0.4/0.15	10/0.4/0.15
Minimum switching load	mW (V/mA)	500 (10/5)	500 (10/5)
Standard contact material		AgNi	AgNi

**Coil specification**

Nominal voltage (U <sub>N</sub> )	V AC (50/60 Hz)	6 - 12 - 24 - 48 - 60 - 110 - 120 - 230 - 240 - 400
	V DC	6 - 12 - 24 - 48 - 60 - 110 - 125 - 220
Rated power AC/DC	VA (50 Hz)/W	2.2/1.3
Operating range	AC	(0.8...1.1)U <sub>N</sub>
	DC	(0.8...1.1)U <sub>N</sub>
Holding voltage	AC/DC	0.8 U <sub>N</sub> / 0.5 U <sub>N</sub>
Must drop-out voltage	AC/DC	0.2 U <sub>N</sub> / 0.1 U <sub>N</sub>

**Technical data**

Mechanical life AC/DC	cycles	20 · 10 <sup>6</sup> / 50 · 10 <sup>6</sup>	20 · 10 <sup>6</sup> / 50 · 10 <sup>6</sup>
Electrical life at rated load AC1	cycles	200 · 10 <sup>3</sup>	200 · 10 <sup>3</sup>
Operate/release time	ms	11/4	11/4
Insulation between coil and contacts (1.2/50 μs)	kV	4	3.6
Dielectric strength between open contacts	V AC	1000	1000
Ambient temperature range	°C	-40...+70	-40...+70
Environmental protection		RT I	RT I

**Approvals** (according to type)



**Plug-in mount - 6 A****Bifurcated contacts for low level switching****Type 60.12 - 52xx**

- 2 pole, 6 A

**Type 60.13 - 52xx**

- 3 pole, 6 A

- 2 & 3 pole changeover contacts
- Cadmium Free contacts (Gold plated Silver Nickel)
- AC coils & DC coils
- Lockable test button with mechanical flag indicator (preferred version)
- 90 series sockets
- Coil EMC suppression
- Timer accessories 86 series
- European Patent

**60.12 - 52xx**

- 2 pole, 6 A
- Bifurcated contacts with AgNi + Au
- 8 pin plug-in

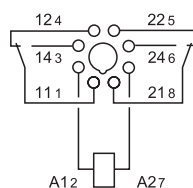
**60.13 - 52xx**

- 3 pole, 6 A
- Bifurcated contacts with AgNi + Au
- 11 pin plug-in

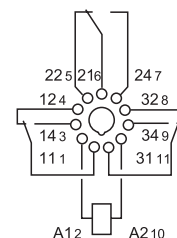

FOR UL RATINGS SEE:

"General technical information" page V

For outline drawing see page 8

**Contact specification**

		2 CO (DPDT)	3 CO (3PDT)
Contact configuration		2 CO (DPDT)	3 CO (3PDT)
Rated current/Maximum peak current	A	6/10	6/10
Rated voltage/Maximum switching voltage	V AC	250/400	250/400
Rated load AC1	VA	1500	1500
Rated load AC15 (230 V AC)	VA	250	250
Single phase motor rating (230 V AC)	kW	0.185	0.185
Breaking capacity DC1: 24/110/220 V	A	6/0.3/0.12	6/0.3/0.12
Minimum switching load	mW (V/mA)	50 (5/5)	50 (5/5)
Standard contact material		AgNi + Au	AgNi + Au

**Coil specification**

		6 - 12 - 24 - 48 - 60 - 110 - 120 - 230 - 240 - 400	6 - 12 - 24 - 48 - 60 - 110 - 125 - 220
Nominal voltage (U <sub>N</sub> )	V AC (50/60 Hz)	6 - 12 - 24 - 48 - 60 - 110 - 120 - 230 - 240 - 400	6 - 12 - 24 - 48 - 60 - 110 - 125 - 220
	V DC	6 - 12 - 24 - 48 - 60 - 110 - 125 - 220	6 - 12 - 24 - 48 - 60 - 110 - 125 - 220
Rated power AC/DC	VA (50 Hz)/W	2.2/1.3	2.2/1.3
Operating range	AC	(0.8...1.1)U <sub>N</sub>	(0.8...1.1)U <sub>N</sub>
	DC	(0.8...1.1)U <sub>N</sub>	(0.8...1.1)U <sub>N</sub>
Holding voltage	AC/DC	0.8 U <sub>N</sub> / 0.5 U <sub>N</sub>	0.8 U <sub>N</sub> / 0.5 U <sub>N</sub>
Must drop-out voltage	AC/DC	0.2 U <sub>N</sub> / 0.1 U <sub>N</sub>	0.2 U <sub>N</sub> / 0.1 U <sub>N</sub>

**Technical data**

Mechanical life AC/DC	cycles	20 · 10 <sup>6</sup> / 50 · 10 <sup>6</sup>	20 · 10 <sup>6</sup> / 50 · 10 <sup>6</sup>
Electrical life at rated load AC1	cycles	250 · 10 <sup>3</sup>	250 · 10 <sup>3</sup>
Operate/release time	ms	11/4	11/4
Insulation between coil and contacts (1.2/50 μs)	kV	4	3.6
Dielectric strength between open contacts	V AC	1000	1000
Ambient temperature range	°C	-40...+70	-40...+70
Environmental protection		RT I	RT I

**Approvals** (according to type)

**Flange mount - General purpose relay 10 A**

**Type 60.62**

- 2 pole, 10 A

**Type 60.63**

- 3 pole, 10 A

- Faston 187, (4.8 x 0.8 mm)
- 2 & 3 pole changeover contacts
- AC coils & DC coils
- Cadmium Free contacts
- Contacts material options

**60.62**



- 2 pole, 10 A power contacts
- Flange mount
- Faston 187

**60.63**

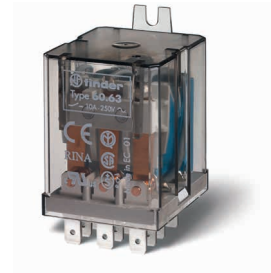

- 3 pole, 10 A power contacts
- Flange mount
- Faston 187

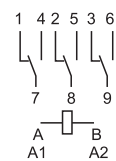
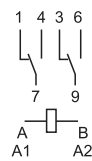

FOR UL RATINGS SEE:

"General technical information" page V

For outline drawing see page 8

**Contact specification**

Contact configuration		2 CO (DPDT)	3 CO (3PDT)
Rated current/Maximum peak current	A	10/20	10/20
Rated voltage/ Maximum switching voltage	V AC	250/400	250/400
Rated load AC1	VA	2500	2500
Rated load AC15 (230 V AC)	VA	500	500
Single phase motor rating (230 V AC)	kW	0.37	0.37
Breaking capacity DC1: 24/110/220 V	A	10/0.4/0.15	10/0.4/0.15
Minimum switching load	mW (V/mA)	500 (10/5)	500 (10/5)
Standard contact material		AgNi	AgNi

**Coil specification**

Nominal voltage (U <sub>N</sub> )	V AC (50/60 Hz)	6 - 12 - 24 - 48 - 60 - 110 - 120 - 230 - 240 - 400	
	V DC	6 - 12 - 24 - 48 - 60 - 110 - 125 - 220	
Rated power AC/DC	VA (50 Hz)/W	2.2/1.3	2.2/1.3
Operating range	AC	(0.8...1.1)U <sub>N</sub>	(0.8...1.1)U <sub>N</sub>
	DC	(0.8...1.1)U <sub>N</sub>	(0.8...1.1)U <sub>N</sub>
Holding voltage	AC/DC	0.8 U <sub>N</sub> / 0.5 U <sub>N</sub>	0.8 U <sub>N</sub> / 0.5 U <sub>N</sub>
Must drop-out voltage	AC/DC	0.2 U <sub>N</sub> / 0.1 U <sub>N</sub>	0.2 U <sub>N</sub> / 0.1 U <sub>N</sub>

**Technical data**

Mechanical life AC/DC	cycles	20 · 10 <sup>6</sup> / 50 · 10 <sup>6</sup>	20 · 10 <sup>6</sup> / 50 · 10 <sup>6</sup>
Electrical life at rated load AC1	cycles	200 · 10 <sup>3</sup>	200 · 10 <sup>3</sup>
Operate/release time	ms	11/4	11/4
Insulation between coil and contacts (1.2/50 μs)	kV	4	3.6
Dielectric strength between open contacts	V AC	1000	1000
Ambient temperature range	°C	-40...+70	-40...+70
Environmental protection		RT I	RT I

**Approvals** (according to type)



## Ordering information

Example: 60 series plug-in relay, 3 CO (3PDT), 12 V DC coil, test button and mechanical indicator.

A

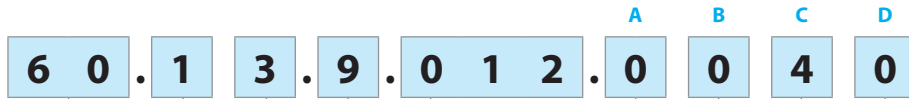

**Series** ————  
**Type** ————  
 1 = 8/11 pin plug-in  
 6 = Faston 187 (4.8 x 0.8 mm) with flange mount  
**No. of poles** ————  
 2 = 2 pole  
 3 = 3 pole  
**Coil version** ————  
 4 = Current sensing (60.12/13 only)  
 8 = AC (50/60 Hz)  
 9 = DC  
**Coil voltage** ————  
 See coil specifications

**A: Contact material**  
 0 = Standard  
 5 = AgNi + Au  
**B: Contact circuit**  
 0 = CO (nPDT)  
 2 = Bifurcated contacts  
 60.12/13 - 6 A only

**D: Special versions**  
 0 = Standard  
**C: Options**  
 0 = None  
 2 = Mechanical indicator  
 3 = LED (AC)  
 4 = Lockable test button + mechanical indicator  
 5\* = Lockable test button + LED (AC)  
 54\* = Lockable test button + LED (AC) + mechanical indicator  
 6\* = LED + diode (DC, polarity positive to pin 2)  
 7\* = Lockable test button + LED + diode (DC, polarity positive to pin 2)  
 74\* = Lockable test button + LED + diode (DC, polarity positive to pin 2) + mechanical indicator  
 \* Options not available for 220 V DC and 400 V AC versions.

**Selecting features and options: only combinations in the same row are possible.**  
 Preferred selections for best availability are shown in **bold**.

Type	Coil version	A	B	C	D
60.12/13	AC	<b>0</b>	<b>0</b>	0 - 2 - 3 - <b>4</b> - 5	<b>0</b>
	AC	0	0	54	/
	AC	5	0 - 2	0 - 2 - 3 - 4 - 5	0
	AC	5	0 - 2	54	/
	DC	<b>0</b>	<b>0</b>	0 - 2 - <b>4</b> - 6 - 7	<b>0</b>
	DC	0	0	74	/
	DC	5	0 - 2	0 - 2 - 4 - 6 - 7	0
	DC	5	0 - 2	74	/
	current sensing	0	0	4	0
60.62/63	AC-DC	<b>0 - 5</b>	<b>0</b>	<b>0</b>	<b>0</b>

### Descriptions: Options and Special versions

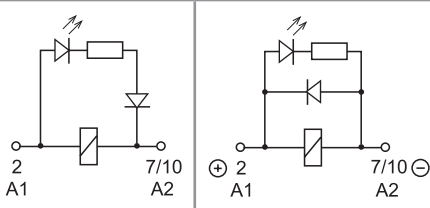

**C: Option 3, 5, 54**  
 LED (AC)  
**C: Option 6, 7, 74**  
 LED + diode (DC, polarity positive to pin 2)



### Lockable test button and mechanical flag indicator (0040, 0050, 0054, 0070, 0074)

The dual-purpose Finder test button can be used in two ways:

**Case 1)** The plastic pip (located directly above the test button) remains intact. In this case, when the test button is pushed, the contacts operate. When the test button is released the contacts return to their former state.

**Case 2)** The plastic pip is broken-off (using an appropriate cutting tool). In this case, (in addition to the above function), when the test button is pushed and rotated, the contacts are latched in the operating state, and remain so until the test button is rotated back to its former position.

In both cases ensure that the test button actuation is swift and decisive.



## Technical data

Insulation according to EN 61810-1		2 pole		3 pole	
Nominal voltage of supply system	V AC	230/400		230/400	
Rated insulation voltage	V AC	250	400	250	400
Pollution degree		3	2	3	2
<b>Insulation between coil and contact set</b>					
Type of insulation		Basic		Basic	
Overvoltage category		III		III	
Rated impulse voltage	kV (1.2/50 μs)	4		3.6	
Dielectric strength	V AC	2000		2000	
<b>Insulation between adjacent contacts</b>					
Type of insulation		Basic		Basic	
Overvoltage category		III		III	
Rated impulse voltage	kV (1.2/50 μs)	4		3.6	
Dielectric strength	V AC	2000		2000	
<b>Insulation between open contacts</b>					
Type of disconnection		Micro-disconnection		Micro-disconnection	
Dielectric strength	V AC/kV (1.2/50 μs)	1000/1.5		1000/1.5	
<b>Insulation between coil terminals</b>					
Rated impulse voltage (surge) differential mode (according to EN 61000-4-5)	kV (1.2/50 μs)	4			
<b>Other data</b>					
Bounce time: NO/NC	ms	1/4			
Vibration resistance (5...55)Hz: NO/NC	g	22/22			
Shock resistance	g	20			
Power lost to the environment	without contact current	W	1.3		1.3
	with rated current	W	2.7 (60.12, 60.62)		3.4 (60.13, 60.63)

## Contact specification

F 60 -Electrical life (AC) v contact current

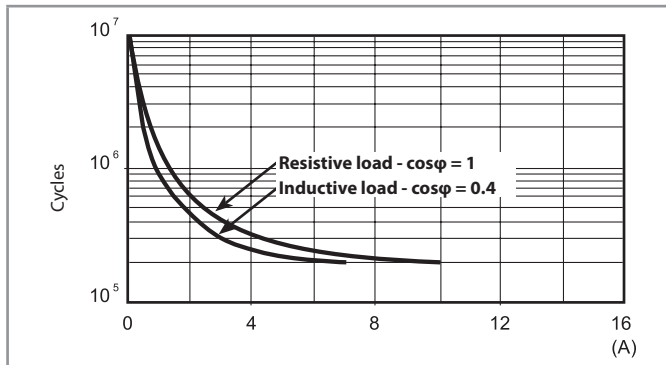

H 60 -Maximum DC1 breaking capacity

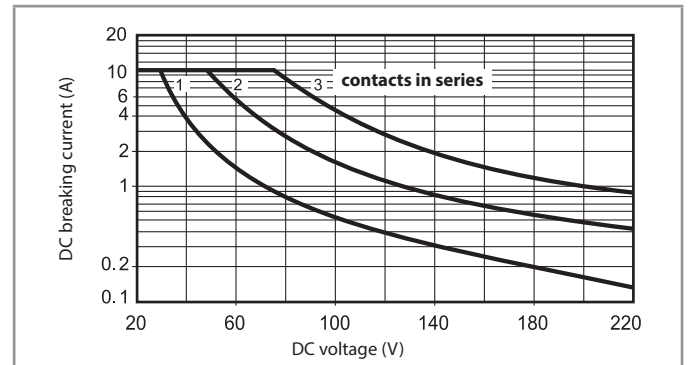

- When switching a resistive load (DC1) having voltage and current values under the curve, an electrical life of  $\geq 100 \cdot 10^3$  can be expected.
- In the case of DC13 loads, the connection of a diode in parallel with the load will permit a similar electrical life as for a DC1 load.  
Note: the release time for the load will be increased.

## Coil specifications

### DC coil data

Nominal voltage $U_N$ V	Coil code	Operating range		Resistance R $\Omega$	Rated coil absorption I at $U_N$ mA
		$U_{min}$ V	$U_{max}$ V		
6	9.006	4.8	6.6	28	214
12	9.012	9.6	13.2	110	109
24	9.024	19.2	26.4	445	53.9
48	9.048	38.4	52.8	1770	27.1
60	9.060	48	66	2760	21.7
110	9.110	88	121	9420	11.7
125	9.125	100	138	12000	10.4
220	9.220	176	242	37300	5.8

### AC coil data

Nominal voltage $U_N$ V	Coil code	Operating range		Resistance R $\Omega$	Rated coil absorption I at $U_N$ (50 Hz) mA
		$U_{min}$ V	$U_{max}$ V		
6	8.006	4.8	6.6	4.6	367
12	8.012	9.6	13.2	19	183
24	8.024	19.2	26.4	74	90
48	8.048	38.4	52.8	290	47
60	8.060	48	66	450	37
110	8.110	88	121	1600	20
120	8.120	96	132	1940	18.6
230	8.230	184	253	7250	10.5
240	8.240	192	264	8500	9.2
400	8.400	320	440	19800	6

### Coil specifications

R 60 - DC coil operating range v ambient temperature

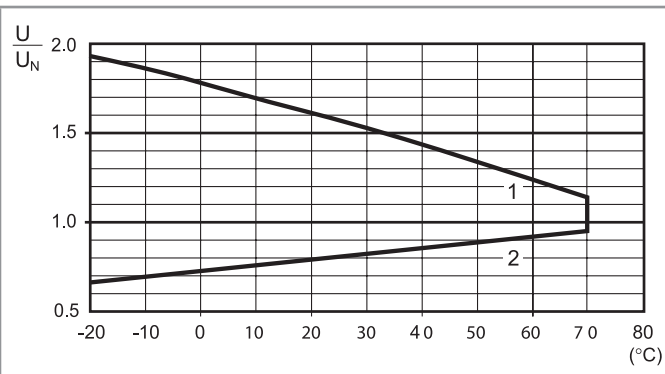

- 1 - Max. permitted coil voltage.
- 2 - Min. pick-up voltage with coil at ambient temperature.

R 60 - AC coil operating range v ambient temperature

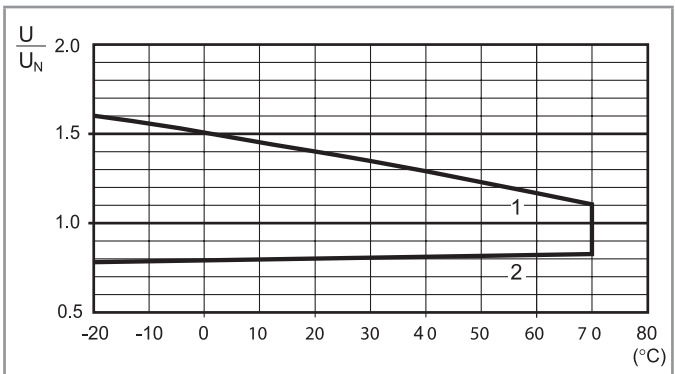

- 1 - Max. permitted coil voltage.
- 2 - Min. pick-up voltage with coil at ambient temperature.

### Current sensing version

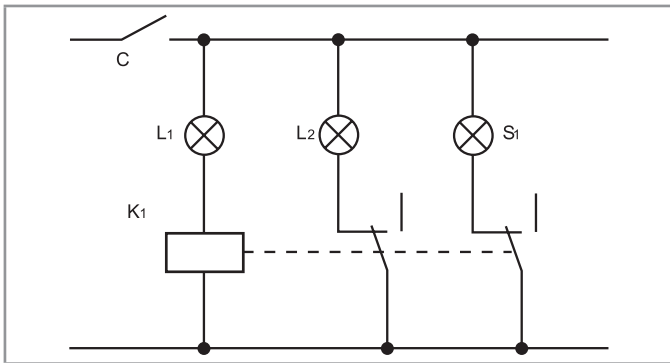

Typical application with current sensing relays.  
An open circuit filament of lamp  $L_1$  is detected by the current sensing relay coil ( $K_1$ ) which causes the back-up safety lamp  $L_2$  to be energised, and indication of failure at the control panel via lamp  $S_1$ .  
Example: navigation light.  
 $L_1$  = Light  
 $L_2$  = Safety light  
 $S_1$  = Control light  
 $K_1$  = Relay

Current sensing DC coil data

Coil code	$I_{min}$ (A)	$I_N$ (A)	$I_{max}$ (A)	R ( $\Omega$ )
4202	1.7	2.0	2.4	0.15
4182	1.5	1.8	2.2	0.19
4162	1.4	1.6	1.9	0.24
4142	1.2	1.4	1.7	0.31
4122	1.0	1.2	1.4	0.42
4102	0.85	1.0	1.2	0.61
4092	0.8	0.9	1.1	0.75
4062	0.5	0.6	0.7	1.70
4032	0.25	0.3	0.4	6.70
4012	0.085	0.1	0.15	61

Current sensing AC coil data

Coil code	$I_{min}$ (A)	$I_N$ (A)	$I_{max}$ (A)	R ( $\Omega$ )
4251	2.1	2.5	3.0	0.05
4181	1.5	1.8	2.2	0.10
4161	1.4	1.6	1.9	0.12
4121	1.0	1.2	1.4	0.22
4101	0.85	1.0	1.2	0.32
4051	0.42	0.5	0.6	1.28
4041	0.34	0.4	0.5	2.00
4031	0.25	0.3	0.4	3.57
4021	0.17	0.2	0.25	8.0
4011	0.085	0.1	0.15	32.1

Other types of current sensing relays are available on request.

### Outline drawings

Type 60.12/60.12 - 52xx

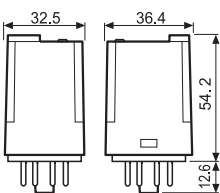

Type 60.13/60.13 - 52xx

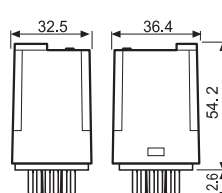

Type 60.62

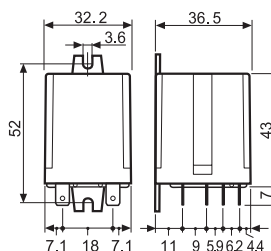

Type 60.63

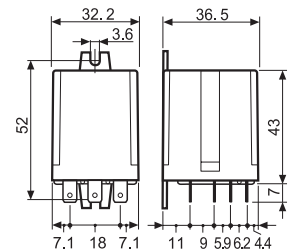



Accessories

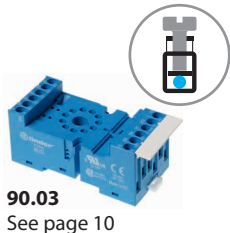

90.03  
See page 10

Module	Socket	Relay	Description	Mounting	Accessories
99.02	90.02	60.12	Screw terminal (Box clamp) socket Double A1 terminal	Panel or 35 mm rail (EN 60715) mount	- Coil indication and EMC suppression modules - Jumper link - Timer modules - Metal retaining clip
	90.03	60.13			



90.21  
See page 11

Module	Socket	Relay	Description	Mounting	Accessories
99.01	90.20	60.12	Screw terminal (Box clamp) socket	Panel or 35 mm rail (EN 60715) mount	- Coil indication and EMC suppression modules - Metal retaining clip
	90.21	60.13			



90.83.3  
See page 12

Module	Socket	Relay	Description	Mounting	Accessories
—	90.82.3	60.12	Screw terminal (Box clamp) socket	Panel or 35 mm rail (EN 60715) mount	- Metal retaining clip
—	90.83.3	60.13			



90.23  
See page 12

Module	Socket	Relay	Description	Mounting	Accessories
—	90.22	60.12	Screw terminal (Box clamp) socket	Panel or 35 mm rail (EN 60715) mount	- Metal retaining clip
—	90.23	60.13			

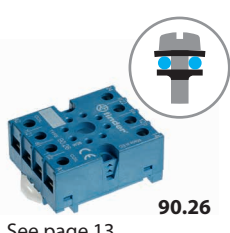

90.26  
See page 13

Module	Socket	Relay	Description	Mounting	Accessories
—	90.26	60.12	Screw terminal (Plate clamp) socket	Panel or 35 mm rail (EN 60715) mount	- Metal retaining clip
—	90.27	60.13			



90.15  
See page 13

Module	Socket	Relay	Description	Mounting	Accessories
—	90.14	60.12	PCB socket	PCB	—
—	90.14.1	60.12			
—	90.15	60.13			
—	90.15.1	60.13			

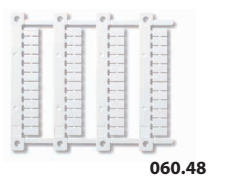

060.48

Sheet of marker tags (CEMBRE Thermal transfer printers) for relay types 60.12 and 60.13, plastic, 48 tags, 6 x 12 mm	060.48
--	--------

A

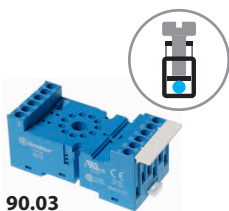

90.03

Approvals  
(according to type):



UL US Certain relay/socket combinations

<b>Screw terminal (Box clamp) socket</b> panel or 35 mm rail (EN 60715) mount	<b>90.02</b> <b>Blue</b>	<b>90.03</b> <b>Blue</b>	
For relay type	60.12	60.13	
<b>Accessories</b>			
Metal retaining clip		090.33	
6-way jumper link		090.06	
Identification tag		090.00.2	
Modules (see table below)		99.02	
Timer modules (see table below)		86.00, 86.30	
<b>Technical data</b>			
Rated values	10 A - 250 V		
Dielectric strength	2 kV AC		
Protection category	IP 20		
Ambient temperature	°C -40...+70		
Screw torque	Nm	0.6	
Wire strip length	mm	10	
Max. wire size for 90.02 and 90.03 sockets	solid wire	stranded wire	
	mm <sup>2</sup>	1 x 6 / 2 x 2.5	1 x 4 / 2 x 2.5
	AWG	1 x 10 / 2 x 14	1 x 12 / 2 x 14

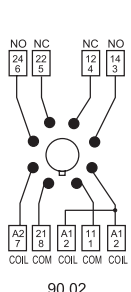

90.02

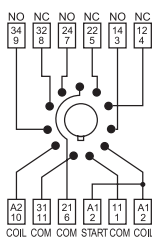
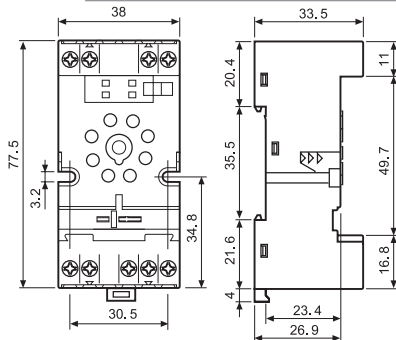

90.03

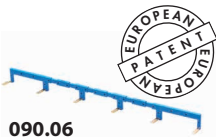
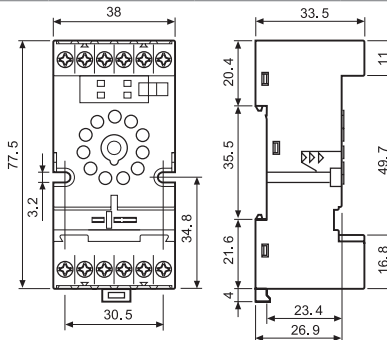

90.06



<b>6-way jumper link</b> for 90.02 and 90.03 sockets	090.06 (blue)	090.06.0 (black)
Rated values	10 A - 250 V	

Approvals  
(according to type):

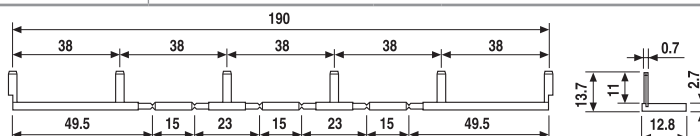

86.00



86.30



99.02

Approvals  
(according to type):



DC Modules with non-standard polarity (+A2) on request.

<b>86 series timer modules</b>		
Multi-voltage: (12...240)V AC/DC;		
Multi-functions: AI, DI, SW, BE, CE, DE, EE, FE; (0.05 s... 100 h)		86.00.0.240.0000
(12...24)V AC/DC; Bi-function: AI, DI; (0.05 s... 100 h)		86.30.0.024.0000
(110...125)V AC; Bi-function: AI, DI; (0.05 s... 100 h)		86.30.8.120.0000
(230...240)V AC; Bi-function: AI, DI; (0.05 s... 100 h)		86.30.8.240.0000

Approvals (according to type):

<b>99.02 coil indication and EMC suppression modules</b> for 90.02 and 90.03 sockets		
Diode (+A1, standard polarity)	(6...220)V DC	99.02.3.000.00
LED	(6...24)V DC/AC	99.02.0.024.59
LED	(28...60)V DC/AC	99.02.0.060.59
LED	(110...240)V DC/AC	99.02.0.230.59
LED + Diode (+A1, standard polarity)	(6...24)V DC	99.02.9.024.99
LED + Diode (+A1, standard polarity)	(28...60)V DC	99.02.9.060.99
LED + Diode (+A1, standard polarity)	(110...220)V DC	99.02.9.220.99
LED + Varistor	(6...24)V DC/AC	99.02.0.024.98
LED + Varistor	(28...60)V DC/AC	99.02.0.060.98
LED + Varistor	(110...240)V DC/AC	99.02.0.230.98
RC circuit	(6...24)V DC/AC	99.02.0.024.09
RC circuit	(28...60)V DC/AC	99.02.0.060.09
RC circuit	(110...240)V DC/AC	99.02.0.230.09
Residual current by-pass*	(110...240)V AC	99.02.8.230.07

\* Additional 0.9 W power dissipation

A



90.21

Approvals  
(according to type):



<b>Screw terminal (Box clamp) socket</b> panel or 35 mm rail (EN 60715) mount	<b>90.20</b> <b>Blue</b>	<b>90.21</b> <b>Blue</b>
For relay type	60.12	60.13
<b>Accessories</b>		
Metal retaining clip (supplied with socket - packaging code SMA)		090.33
Modules (see table below)		99.01
<b>Technical data</b>		
Rated values	10 A - 250 V	
Dielectric strength	2 kV AC	
Protection category	IP 20	
Ambient temperature	°C -40...+70	
Screw torque	Nm	0.5
Wire strip length	mm	10
Max. wire size for 90.20 and 90.21 sockets	solid wire	stranded wire
	mm <sup>2</sup>	1 x 6 / 2 x 2.5
	AWG	1 x 10 / 2 x 14

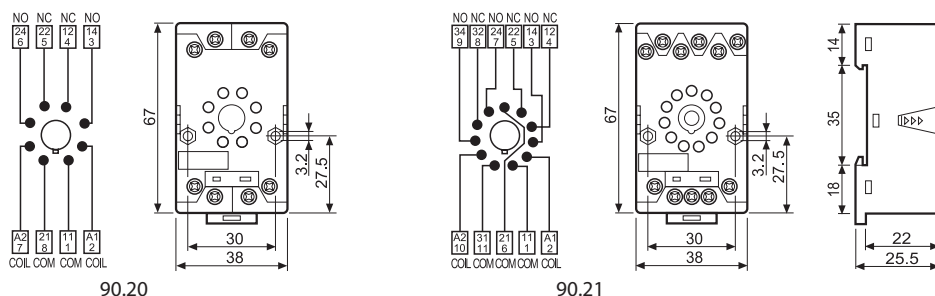

99.01

Approvals  
(according to type):



\* Modules in Black housing are available on request.

Green LED is standard.  
Red LED available on request.

99.01 coil indication and EMC suppression modules for 90.20 and 90.21 sockets		Blue*
Diode (+A1, standard polarity)	(6...220)V DC	99.01.3.000.00
Diode (+A2, non-standard polarity)	(6...220)V DC	99.01.2.000.00
LED	(6...24)V DC/AC	99.01.0.024.59
LED	(28...60)V DC/AC	99.01.0.060.59
LED	(110...240)V DC/AC	99.01.0.230.59
LED + Diode (+A1, standard polarity)	(6...24)V DC	99.01.9.024.99
LED + Diode (+A1, standard polarity)	(28...60)V DC	99.01.9.060.99
LED + Diode (+A1, standard polarity)	(110...220)V DC	99.01.9.220.99
LED + Diode (+A2, non-standard polarity)	(6...24)V DC	99.01.9.024.79
LED + Diode (+A2, non-standard polarity)	(28...60)V DC	99.01.9.060.79
LED + Diode (+A2, non-standard polarity)	(110...220)V DC	99.01.9.220.79
LED + Varistor	(6...24)V DC/AC	99.01.0.024.98
LED + Varistor	(28...60)V DC/AC	99.01.0.060.98
LED + Varistor	(110...240)V DC/AC	99.01.0.230.98
RC circuit	(6...24)V DC/AC	99.01.0.024.09
RC circuit	(28...60)V DC/AC	99.01.0.060.09
RC circuit	(110...240)V DC/AC	99.01.0.230.09
Residual current by-pass *	(110...240)V AC	99.01.8.230.07

\* Additional 0.9 W power dissipation

A

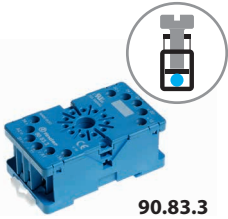

90.83.3

Approvals  
(according to type):



<b>Screw terminal (Box clamp) socket</b> panel or 35 mm rail (EN 60715) mount	<b>90.82.3</b> <b>Blue</b>	<b>90.83.3</b> <b>Blue</b>
For relay type	60.12	60.13
<b>Accessories</b>		
Metal retaining clip	090.33	
<b>Technical data</b>		
Rated values	10 A - 250 V	
Dielectric strength	2 kV AC	
Protection category	IP 20	
Ambient temperature	°C -40...+70	
Screw torque	Nm 0.8	
Max. wire size for 90.82.3 and 90.83.3 sockets	solid wire	stranded wire
	mm <sup>2</sup> 1 x 6 / 2 x 4	1 x 6 / 2 x 4
	AWG 1 x 10 / 2 x 14	1 x 10 / 2 x 14

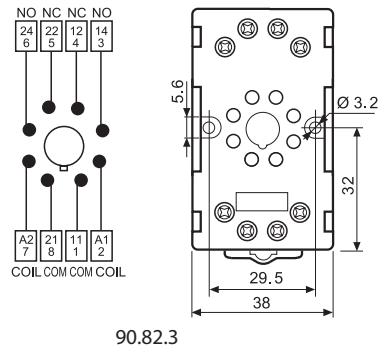

90.82.3

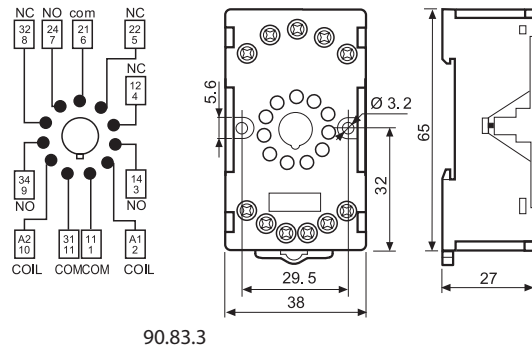

90.83.3



90.23

Approvals  
(according to type):



<b>Screw terminal (Box clamp) socket</b> panel or 35 mm rail (EN 60715) mount	<b>90.22</b> <b>Blue</b>	<b>90.23</b> <b>Blue</b>
For relay type	60.12	60.13
<b>Accessories</b>		
Metal retaining clip (supplied with socket - packaging code SMA)	090.33	
<b>Technical data</b>		
Rated values	10 A - 250 V	
Dielectric strength	2 kV AC	
Protection category	IP 20	
Ambient temperature	°C -40...+70	
Screw torque	Nm 0.5	
Wire strip length	mm 7	
Max. wire size for 90.22 and 90.23 sockets	solid wire	stranded wire
	mm <sup>2</sup> 1 x 6 / 2 x 2.5	1 x 6 / 2 x 2.5
	AWG 1 x 10 / 2 x 14	1 x 10 / 2 x 14

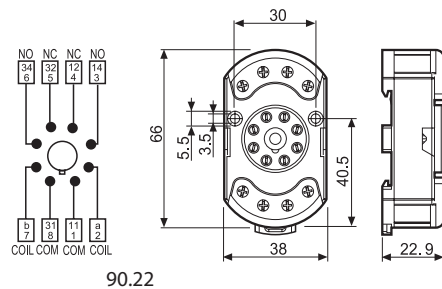

90.22

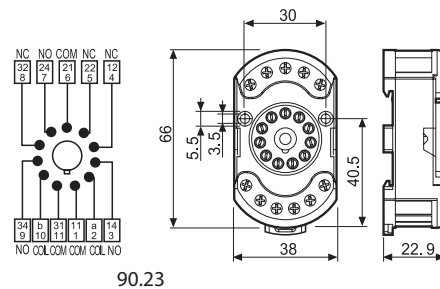

90.23

A

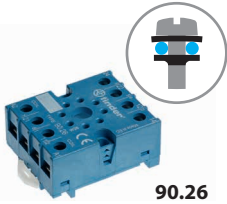

90.26

Approvals  
(according to type):



<b>Screw terminal (Box clamp) socket</b> panel or 35 mm rail (EN 60715) mount	<b>90.26</b> <b>Blue</b>	<b>90.27</b> <b>Blue</b>
For relay type	60.12	60.13
<b>Accessories</b>		
Metal retaining clip (supplied with socket - packaging code SMA)		090.33
<b>Technical data</b>		
Rated values	10 A - 250 V	
Dielectric strength	2 kV AC	
Protection category	IP 20	
Ambient temperature	°C -40...+70	
Screw torque	Nm 0.8	
Wire strip length	mm 10	
Max. wire size for 90.26 and 90.27 sockets	solid wire	stranded wire
	mm <sup>2</sup> 1 x 4 / 2 x 2.5	1 x 4 / 2 x 2.5
	AWG 1 x 12 / 2 x 14	1 x 12 / 2 x 14

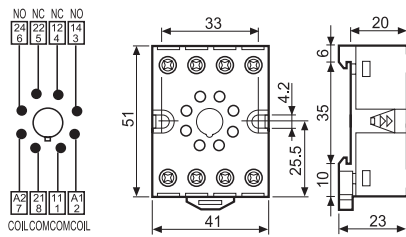

90.26

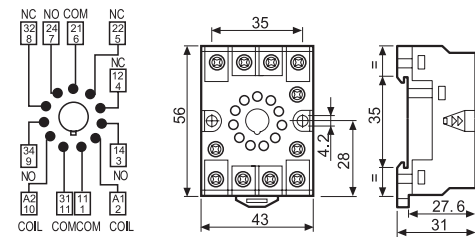

90.27



90.15

Approvals  
(according to type):



<b>PCB socket</b>	<b>Blue</b>	<b>90.14 (Ø 20.5 mm)</b>	<b>90.15 (Ø 22 mm)</b>
	<b>Blue</b>	<b>90.14.1 (Ø 17.5 mm)</b>	<b>90.15.1 (Ø 19 mm)</b>
For relay type		60.12	60.13
<b>Technical data</b>			
Rated values	10 A - 250 V		
Dielectric strength	2 kV AC		
Ambient temperature	°C -40...+70		

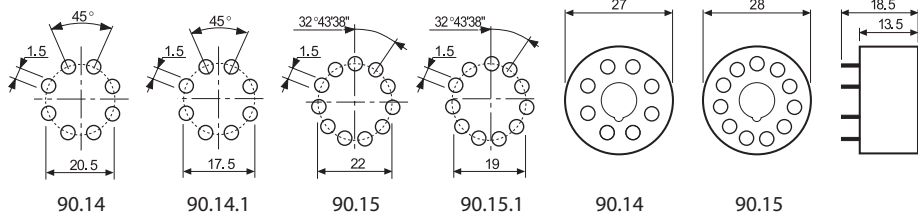

90.14

90.14.1

90.15

90.15.1

90.14

90.15

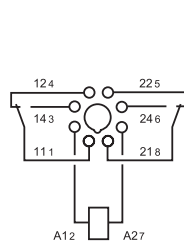

90.14

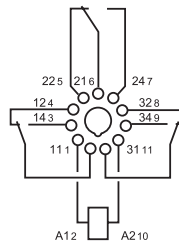

90.15

## Packaging codes

How to code and identify retaining clip and packaging options for sockets.

A

Example:

